

**Dwarsafvoerbanden
onderdelenoverzicht**

Querförderband Ersatzteilübersicht

Cross conveyor spare parts list

Amigo / Feedo

1995 - 2022

VERSION 1.7

Schuitemaker

INHOUDSOPGAVE / TABLE OF CONTENTS / INHALTSVERZEICHNIS

1. Bouwjaar / BAUJAHR / CONSTRUCTION YEAR 1995 – 2005.....	5
A. Transportband / Querförderband / conveyor belt*	5
B. Afdichtstrook / Dichtungsstreifen / closure strip*	5
C. Geleideprofiel / Führungsprofil / guide profile*	5
D. Afschermring / Dichtungsring / closure ring**	6
E. Banddrijfrol / Antriebsrolle / Drive roller.....	6
F. Spanrol / Spannrolle / Tension roller.....	6
G. Lager / Lager / bearing	7
2. Bouwjaar / BAUJAHR / CONSTRUCTION YEAR 2005 – 2006.....	8
A. Transportband / Querförderband / conveyor belt*	8
B. Afdichtstrook / Dichtungsstreifen / closure strip*	8
C. Geleideprofiel / Führungsprofil / guide profile*	8
D. Afschermring / Dichtungsring / closure ring**	9
E. Banddrijfrol / Antriebsrolle / Drive roller.....	9
F. Spanrol / Spannrolle / Tension roller.....	9
G. Lager / Lager / bearing	10
3. Bouwjaar / BAUJAHR / CONSTRUCTION YEAR 2006 – 2008.....	11
A. Transportband / Querförderband / conveyor belt*	11
B. Afdichtstrook / Dichtungsstreifen / closure strip*	11
C. Geleideprofiel / Führungsprofil / guide profile*	11
D. Afschermring / Dichtungsring / closure ring**	12
E. Banddrijfrol / Antriebsrolle / Drive roller.....	12
F. Spanrol / Spannrolle / Tension roller.....	12
G. Lager / Lager / bearing	13
4. Bouwjaar / BAUJAHR / CONSTRUCTION YEAR 2008 – 2010.....	14
A. Transportband / Querförderband / conveyor belt	14
B. Afdichtstrook / Dichtungsstreifen / closure strip.....	14
C. Geleideprofiel / Führungsprofil / guide profile.....	14
D. Afschermring / Dichtungsring / closure ring.....	15
E. Banddrijfrol / Antriebsrolle / Drive roller.....	15
F. Spanrol / Spannrolle / Tension roller.....	16
G. Lager / Lager / bearing	16
5. Bouwjaar / BAUJAHR / CONSTRUCTION YEAR 2010 – 2014.....	17

A.	Transportband / Querförderband / conveyor belt	17
B.	Afdichtstrook / Dichtungsstreifen / closure strip.....	17
C.	Geleideprofiel / Führungsprofil / guide profile.....	17
D.	Afschermring / Dichtungsring / closure ring.....	18
E.	Banddrijfrol / Antriebsrolle / Drive roller.....	18
F.	Spanrol / Spannrolle / Tension roller	18
G.	Lager / Lager / bearing	19
6.	Bouwjaar / BAUJAHR / CONSTRUCTION YEAR 2014 – 2017.....	20
A.	Transportband / Querförderband / conveyor belt*	20
B.	Afdichtstrook / Dichtungsstreifen / closure strip*	20
C.	Geleideprofiel / Führungsprofil / guide profile*	20
D.	Afschermring / Dichtungsring / closure ring**	21
E.	Banddrijfrol / Antriebsrolle / Drive roller.....	21
F.	Spanrol / Spannrolle / Tension roller	21
G.	Lager / Lager / bearing	22
7.	Bouwjaar / BAUJAHR / CONSTRUCTION YEAR 2018 – 2022.....	23
A.	Transportband / Querförderband / conveyor belt*	23
B.	Afdichtstrook / Dichtungsstreifen / closure strip*	23
C.	Geleideprofiel / Führungsprofil / guide profile*	23
D.	Afschermring / Dichtungsring / closure ring**	24
E.	Banddrijfrol / Antriebsrolle / Drive roller.....	24
F.	Spanrol / Spannrolle / Tension roller	24
G.	Lager / Lager / bearing	25
8.	Montage Instructies / Montage Anleitung / assembly instructions.....	26
A.	Transportband / Querförderband / conveyor belt	26
B.	Banddrijfrol & Spanrol / Antriebsrolle & Spannrolle / Drive roller & Tension roller	26
C.	Olieopbrengst / Ölfluss / Oil flow	27
D.	Geleideprofiel / Führungsprofil / guide profile.....	27
E.	Afdichtstrook / Dichtungsstreifen / closure strip.....	28
9.	Foto's artikelen / Bilder Artikeln / Photos Articles	29



Kijk op pagina 26, 27 en 28 / Siehe Seite 26, 27 und 28 / See page 26, 27 and 28

1. BOUWJAAR / BAUJAHR / CONSTRUCTION YEAR 1995 – 2005



A. Transportband / Querförderband / conveyor belt*

A1 Oorspronkelijk / ursprünglich / originally				
Amigo / Feedo	↔ [mm]	Art.nr.	↕ [mm]	Verkrijgbaar Verfügbar Available
Amigo 15	600	433.0020	4400	✘
Amigo 20 / 30 / 40	600	433.0035	4600	✘
Feedo 40L	600	433.0048	3200	✘
Feedo 40 / 50 / 60L	600	433.0044	3800	✘
Feedo 60 / 70 / 80	600	433.0020	4400	✘
Feedo 100 - 200	600	433.0054	5000	✘

A2 Vervanging / ersatz / replacement	
Art.nr.	↕ [mm]
433.1130 + B2 + C2	4400
433.1131 + B2 + C2	4550
433.1126 + B2 + C2	3200
433.1128 + B2 + C2	3800
433.1130 + B2 + C2	4400
433.1133 + B2 + C2	5000



B. Afdichtstrook / Dichtungsstreifen / closure strip*

B1 Oorspronkelijk / ursprünglich / originally			
Amigo / Feedo	A1 ↔ [mm]	Art.nr.	Verkrijgbaar Verfügbar Available
All	600	2x 281.0006 	✓

B2 Vervanging / ersatz / replacement	
Art.nr.	
2x 2,5 meter 281.0074 + C2 + A2   	

C. Geleideprofiel / Führungsprofil / guide profile*

C1 Oorspronkelijk / ursprünglich / originally			
Amigo / Feedo	A1 ↔ [mm]	Art.nr.	Verkrijgbaar Verfügbar Available
All	600	✘	✘

C2 Vervanging / ersatz / replacement	
Art.nr.	
2x 902.0943 + B2 + A2   	



D. Afschermring / Dichtungsring / closure ring**

D1 Oorspronkelijk / ursprünglich / originally			
Amigo / Feedo	A1 [mm]	Art.nr.	Verkrijgbaar Verfügbar Available
All	600	2x 360.0005 	✓

D2 Vervanging / ersatz / replacement	
Art.nr.	
✗	

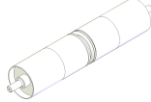

E. Banddrijfrol / Antriebsrolle / Drive roller

E1 Oorspronkelijk / ursprünglich / originally			
Amigo / Feedo	A1 [mm]	Art.nr.	Verkrijgbaar Verfügbar Available
All	600	968.0152 	✗

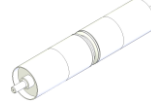

E2 Vervanging / ersatz / replacement	
Art.nr.	
969.4635 + 2x 921.1286  	

F. Spanrol / Spannrolle / Tension roller

F1 Oorspronkelijk / ursprünglich / originally			
Amigo / Feedo	A1 [mm]	Art.nr.	Verkrijgbaar Verfügbar Available
All	600	968.0151 	✗

F2 Vervanging / ersatz / replacement	
Art.nr.	
969.4653 + 2x 921.1286  	

G. Lager / Lager / bearing

G1 Oorspronkelijk / ursprünglich / originally			
Amigo / Feedo	A1 ↔ [mm]	Art.nr.	Verkrijgbaar Verfügbar Available
All	600	3x 401.0169 	✓
All	600	2x 401.0170 	✓
All	600	2x 401.0249 	✓

G2 Vervanging / ersatz / replacement
Art.nr.
✗
✗
✗

- * NL: Schuitemaker raadt het af om de oude afdichtstroken 281.0006 te gebruiken in combinatie met nieuwe transportbanden 433.11xx!
- * DE: Schuitemaker rät ausdrücklich von der Benutzung der alten Dichtungen 281.0006, in Verbindung mit den neuen Querförderbändern 433.11xx, ab!
- * ENG: Schuitemaker discourage to use the old closure strips 281.0006 in combination with the new conveyor belts 433.11xx!

- ** NL: Schuitemaker raadt het af om de oude afschermring 360.0005 te gebruiken in combinatie met nieuwe transportbanden 433.11xx!
- ** DE: Schuitemaker rät ab die Kunststoffschutzringe 360.0005 in Kombination den neuen Querförderbändern 433.11xx zu verwenden!
- ** ENG: Schuitemaker discourage to use the old closure ring 360.0005 in combination with the new conveyor belts 433.11xx!

2. BOUWJAAR / BAUJAHR / CONSTRUCTION YEAR 2005 – 2006



A. Transportband / Querförderband / conveyor belt*

A1 Oorspronkelijk / ursprünglich / originally				
Amigo / Feedo	↔ [mm]	Art.nr.	↕ [mm]	Verkrijgbaar Verfügbar Available
Amigo 20	600	433.1064	4400	x
Amigo 30 / 40	600	433.1065	4550	x
Feedo 40L	600	433.1058	3200	x
Feedo 40 / 50 / 60L	600	433.1061	3800	x
Feedo 60 / 70 / 80	600	433.1064	4400	x
Feedo 100 - 200	600	433.1067	5000	x
	800	433.1003	5000	x

A2 Vervanging / ersatz / replacement	
Art.nr.	↕ [mm]
433.1130 + B2 + C2	4400
433.1131 + B2 + C2	4550
433.1126 + B2 + C2	3200
433.1128 + B2 + C2	3800
433.1130 + B2 + C2	4400
433.1133 + B2 + C2	5000
433.1150 + B2 + C2	5000



B. Afdichtstrook / Dichtungsstreifen / closure strip*

B1 Oorspronkelijk / ursprünglich / originally			
Amigo / Feedo	A1 ↔ [mm]	Art.nr.	Verkrijgbaar Verfügbar Available
All	600/800	2 x 2,5 meter 281.0044 	✓

B2 Vervanging / ersatz / replacement	
Art.nr.	
2x 2,5 meter 281.0074 + C2 + A2 	
 	

C. Geleideprofiel / Führungsprofil / guide profile*

C1 Oorspronkelijk / ursprünglich / originally			
Amigo / Feedo	A1 ↔ [mm]	Art.nr.	Verkrijgbaar Verfügbar Available
All	600 / 800	2 x 2,5 meter 902.0920 	x



C2 Vervanging / ersatz / replacement	
Art.nr.	
2x 902.0943 + B2 + A2 	
 	



D. Afschermring / Dichtungsring / closure ring**

D1 Oorspronkelijk / ursprünglich / originally			
Amigo / Feedo	A1 ↔ [mm]	Art.nr.	Verkrijgbaar Verfügbar Available
All	600 / 800	2x 360.0005 	✓



D2 Vervanging / ersatz / replacement
Art.nr.
✗



E. Banddrijfrol / Antriebsrolle / Drive roller

E1 Oorspronkelijk / ursprünglich / originally			
Amigo / Feedo	A1 ↔ [mm]	Art.nr.	Verkrijgbaar Verfügbar Available
All	600	968.0152 	✗
All	800	969.1718 	✗



E2 Vervanging / ersatz / replacement
Art.nr.
969.4635 + 2x 921.1286 
969.4636 + 2x 921.1286 

F. Spanrol / Spannrolle / Tension roller

F1 Oorspronkelijk / ursprünglich / originally			
Amigo / Feedo	A1 ↔ [mm]	Art.nr.	Verkrijgbaar Verfügbar Available
All	600	968.0151 	✗
All	800	969.2189 	✗

F2 Vervanging / ersatz / replacement
Art.nr.
969.4653 + 2x 921.1286 
969.4654 + 2x 921.1286 

G. Lager / Lager / bearing

G1 Oorspronkelijk / ursprünglich / originally			
Amigo / Feedo	A1 ↔ [mm]	Art.nr.	Verkrijgbaar Verfügbar Available
All	600 / 800	3x 401.0169 	✓
All	600 / 800	2x 401.0170 	✓
All	600 / 800	2x 401.0249 	✓

G2 Vervanging / ersatz / replacement
Art.nr.
✗
✗
✗

- * NL: Schuitemaker raadt het af om de oude afdichtstroken 281.0006 te gebruiken in combinatie met nieuwe transportbanden 433.11xx!
- * DE: Schuitemaker rät ausdrücklich von der Benutzung der alten Dichtungen 281.0006, in Verbindung mit den neuen Querförderbändern 433.11xx, ab!
- * ENG: Schuitemaker discourage to use the old closure strips 281.0006 in combination with the new conveyor belts 433.11xx!

- ** NL: Schuitemaker raadt het af om de oude afschermring 360.0005 te gebruiken in combinatie met nieuwe transportbanden 433.11xx!
- ** DE: Schuitemaker rät ab die Kunststoffschutzringe 360.0005 in Kombination den neuen Querförderbändern 433.11xx zu verwenden!
- ** ENG: Schuitemaker discourage to use the old closure ring 360.0005 in combination with the new conveyor belts 433.11xx!

3. BOUWJAAR / BAUJAHR / CONSTRUCTION YEAR 2006 – 2008



A. Transportband / Querförderband / conveyor belt*

A1 Oorspronkelijk / ursprünglich / originally				
Amigo / Feedo	↔ [mm]	Art.nr.	↕ [mm]	Verkrijgbaar Verfügbar Available
Amigo 20	600	433.1064	4400	✘
Amigo 30 / 40	600	433.1065	4550	✘
Feedo 40L	800	433.1079	3150	✘
Feedo 40 / 50 / 60L	800	433.1080	3750	✘
Feedo 60 / 70 / 80	800	433.1081	4350	✘
Feedo 100 - 200	800	433.1078	4950	✘

A2 Vervanging / ersatz / replacement	
Art.nr.	↕ [mm]
433.1130 + B2 + C2	4400
433.1131 + B2 + C2	4550
433.1143 + B2 + C2	3150
433.1145 + B2 + C2	3750
433.1146 + B2 + C2	4350
433.1149 + B2 + C2	4950



B. Afdichtstrook / Dichtungsstreifen / closure strip*

B1 Oorspronkelijk / ursprünglich / originally			
Amigo / Feedo	A1 ↔ [mm]	Art.nr.	Verkrijgbaar Verfügbar Available
All	600/800	2 x 2,5 meter 281.0044 	✓

B2 Vervanging / ersatz / replacement
Art.nr.
2x 2,5 meter 281.0074 + C2 + A2   

C. Geleideprofiel / Führungsprofil / guide profile*

C1 Oorspronkelijk / ursprünglich / originally			
Amigo / Feedo	A1 ↔ [mm]	Art.nr.	Verkrijgbaar Verfügbar Available
All	600 / 800	2 x 2,5 meter 902.0920 	✘



C2 Vervanging / ersatz / replacement
Art.nr.
2x 902.0943 + B2 + A2   





D. Afschermring / Dichtungsring / closure ring**

D1 Oorspronkelijk / ursprünglich / originally			
Amigo / Feedo	A1 [mm]	Art.nr.	Verkrijgbaar Verfügbar Available
All	600 / 800	2x 360.0005 	✓

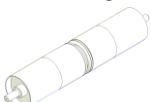

D2 Vervanging / ersatz / replacement	
Art.nr.	
✗	

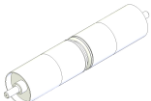



E. Banddrijfrol / Antriebsrolle / Drive roller

E1 Oorspronkelijk / ursprünglich / originally			
Amigo / Feedo	A1 [mm]	Art.nr.	Verkrijgbaar Verfügbar Available
All	600	968.0152 	✗
All	800	969.1718 	✗

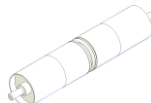

E2 Vervanging / ersatz / replacement	
Art.nr.	
969.4635 + 2x 921.1286  	
969.4636 + 2x 921.1286  	

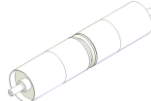
F. Spanrol / Spannrolle / Tension roller

F1 Oorspronkelijk / ursprünglich / originally			
Amigo / Feedo	A1 [mm]	Art.nr.	Verkrijgbaar Verfügbar Available
All	600	968.0151 	✗
All	800	969.2189 	✗

F2 Vervanging / ersatz / replacement	
Art.nr.	
969.4653 + 2x 921.1286  	
969.4654 + 2x 921.1286  	

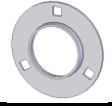
G. Lager / Lager / bearing

G1 Oorspronkelijk / ursprünglich / originally			
Amigo / Feedo	A1 ←→ [mm]	Art.nr.	Verkrijgbaar Verfügbar Available
All	600 / 800	3x 401.0169 	✓
All	600 / 800	2x 401.0170 	✓
All	600 / 800	2x 401.0249 	✓

G2 Vervanging / ersatz / replacement
Art.nr.
✗
✗
✗

- * NL: Schuitemaker raadt het af om de oude afdichtstroken 281.0006 te gebruiken in combinatie met nieuwe transportbanden 433.11xx!
- * DE: Schuitemaker rät ausdrücklich von der Benutzung der alten Dichtungen 281.0006, in Verbindung mit den neuen Querförderbändern 433.11xx, ab!
- * ENG: Schuitemaker discourage to use the old closure strips 281.0006 in combination with the new conveyor belts 433.11xx!

- ** NL: Schuitemaker raadt het af om de oude afschermring 360.0005 te gebruiken in combinatie met nieuwe transportbanden 433.11xx!
- ** DE: Schuitemaker rät ab die Kunststoffschutzringe 360.0005 in Kombination den neuen Querförderbändern 433.11xx zu verwenden!
- ** ENG: Schuitemaker discourage to use the old closure ring 360.0005 in combination with the new conveyor belts 433.11xx!



4. BOUWJAAR / BAUJAHR / CONSTRUCTION YEAR 2008 – 2010

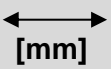
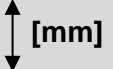

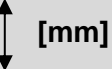
A. Transportband / Querförderband / conveyor belt

A1 Oorspronkelijk / ursprünglich / originally				
Amigo / Feedo	 [mm]	Art.nr.	 [mm]	Verkrijgbaar Verfügbar Available
Amigo 20	600	433.1094	4450	✘
Amigo 30 / 40	600	433.1095	4650	✘
Feedo 40L	800	433.1090	3250	✘
Feedo 40 / 50 / 60L	800	433.1091	3850	✘
Feedo 60 / 70 / 80	800	433.1092	4450	✘
Feedo 100 - 200	800	433.1093	5050	✘

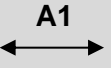

A2 Vervanging / ersatz / replacement	
Art.nr.	 [mm]
433.1123 + B2 + C2	4450
433.1124 + B2 + C2	4650
433.1119 + B2 + C2	3250
433.1120 + B2 + C2	3850
433.1121 + B2 + C2	4450
433.1122 + B2 + C2	5050



B. Afdichtstrook / Dichtungsstreifen / closure strip

B1 Oorspronkelijk / ursprünglich / originally			
Amigo / Feedo	A1  [mm]	Art.nr.	Verkrijgbaar Verfügbar Available
All	600/800	2 x 2,5 meter 281.0044 	✔

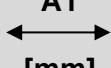
B2 Vervanging / ersatz / replacement	
Art.nr.	
2x 2,5 meter 281.0074 + C2 + A2   	

C. Geleideprofiel / Führungsprofil / guide profile

C1 Oorspronkelijk / ursprünglich / originally			
Amigo / Feedo	A1  [mm]	Art.nr.	Verkrijgbaar Verfügbar Available
All	600 / 800	2 x 2,5 meter 902.0920 	✘



C2 Vervanging / ersatz / replacement	
Art.nr.	
2x 902.0943 + B2 + A2   	



D. Afschermring / Dichtungsring / closure ring

D1 Oorspronkelijk / ursprünglich / originally			
Amigo / Feedo	A1 ↔ [mm]	Art.nr.	Verkrijgbaar Verfügbar Available
All	600 / 800	3x 224.0773 	✓



D2 Vervanging / ersatz / replacement
Art.nr.
✗

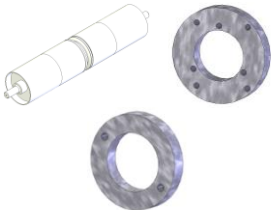

E. Banddrijfrol / Antriebsrolle / Drive roller

E1 Oorspronkelijk / ursprünglich / originally			
Amigo / Feedo	A1 ↔ [mm]	Art.nr.	Verkrijgbaar Verfügbar Available
All	600	969.4679 	✗
All	800	969.4686 	✗

E2 Vervanging / ersatz / replacement
Art.nr.
969.4635 + 1x 921.1286 + 1x 921.1200 
969.4636 + 1x 921.1286 + 921.1200 

F. Spanrol / Spannrolle / Tension roller

F1 Oorspronkelijk / ursprünglich / originally			
Amigo / Feedo	A1 ↔ [mm]	Art.nr.	Verkrijgbaar Verfügbar Available
All	600	969.4680 	✘
All	800	969.4687 	✘

F2 Vervanging / ersatz / replacement	
Art.nr.	
969.4653 + 2x 921.1200 	
969.4654 + 2x 921.1200 	

G. Lager / Lager / bearing

G1 Oorspronkelijk / ursprünglich / originally			
Amigo / Feedo	A1 ↔ [mm]	Art.nr.	Verkrijgbaar Verfügbar Available
All	600 / 800	3x 900.0580 	✔

G2 Vervanging / ersatz / replacement	
Art.nr.	
✘	



5. BOUWJAAR / BAUJAHR / CONSTRUCTION YEAR 2010 – 2014

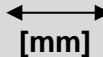
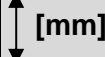

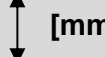
A. Transportband / Querförderband / conveyor belt

A1 Oorspronkelijk / ursprünglich / originally				
Amigo / Feedo	 [mm]	Art.nr.	 [mm]	Verkrijgbaar Verfügbar Available
Amigo 20	600	433.1094	4450	✘
Amigo 30 / 40	600	433.1095	4650	✘
Feedo 40L	800	433.1090	3250	✘
Feedo 40 / 50 / 60L	800	433.1091	3850	✘
Feedo 60 / 70 / 80	800	433.1092	4450	✘
Feedo 100 - 200	800	433.1093	5050	✘

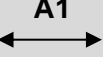

A2 Vervanging / ersatz / replacement	
Art.nr.	 [mm]
433.1123 + B2 + C2	4450
433.1124 + B2 + C2	4650
433.1119 + B2 + C2	3250
433.1120 + B2 + C2	3850
433.1121 + B2 + C2	4450
433.1122 + B2 + C2	5050



B. Afdichtstrook / Dichtungsstreifen / closure strip

B1 Oorspronkelijk / ursprünglich / originally			
Amigo / Feedo	A1  [mm]	Art.nr.	Verkrijgbaar Verfügbar Available
All	600/800	2 x 2,5 meter 281.0044 	✓

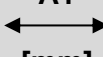
B2 Vervanging / ersatz / replacement	
Art.nr.	
2x 2,5 meter 281.0074 + C2 + A2   	

C. Geleideprofiel / Führungsprofil / guide profile

C1 Oorspronkelijk / ursprünglich / originally			
Amigo / Feedo	A1  [mm]	Art.nr.	Verkrijgbaar Verfügbar Available
All	600 / 800	2 x 2,5 meter 902.0934 	✓

C2 Vervanging / ersatz / replacement	
Art.nr.	
2x 902.0943 + B2 + A2   	

D. Afschermring / Dichtungsring / closure ring

D1 Oorspronkelijk / ursprünglich / originally			
Amigo / Feedo	A1 [mm]	Art.nr.	Verkrijgbaar Verfügbar Available
All	600 / 800	3x 921.1200 + 1x 921.1201 	✓

D2 Vervanging / ersatz / replacement
Art.nr.
✗

E. Banddrijfrol / Antriebsrolle / Drive roller

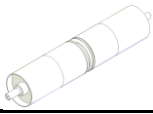
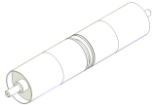
E1 Oorspronkelijk / ursprünglich / originally			
Amigo / Feedo	A1 [mm]	Art.nr.	Verkrijgbaar Verfügbar Available
All	600	969.4635 	✓
All	800	969.4636 	✓

E2 Vervanging / ersatz / replacement
Art.nr.
✗
✗

F. Spanrol / Spannrolle / Tension roller

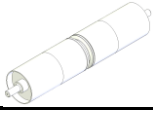
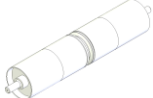
F1 Oorspronkelijk / ursprünglich / originally			
Amigo / Feedo	A1 [mm]	Art.nr.	Verkrijgbaar Verfügbar Available
All	600	969.4653 	✓
All	800	969.4654 	✓

F2 Vervanging / ersatz / replacement
Art.nr.
✗
✗



G. Lager / Lager / bearing

G1 Oorspronkelijk / ursprünglich / originally			
Amigo / Feedo	A1 ↔ [mm]	Art.nr.	Verkrijgbaar Verfügbar Available
All	600 / 800	3x 900.0580 	✓

G2 Vervanging / ersatz / replacement
Art.nr.
✗



6. BOUWJAAR / BAUJAHR / CONSTRUCTION YEAR 2014 – 2017

A. Transportband / Querförderband / conveyor belt*



A1 Oorspronkelijk / ursprünglich / originally				
Amigo / Feedo	 [mm]	Art.nr.	 [mm]	Verkrijgbaar Verfügbar Available
Amigo 20	600	433.1123	4450	✓
Amigo 30S / 40S	600	433.1124	4650	✓
	800	433.1156	4650	✓
Amigo 30W	800	433.1156	4650	✓
Feedo 40L	800	433.1119	3250	✓
Feedo 40 / 50 / 60L	800	433.1120	3850	✓
Feedo 60 / 70 / 80	800	433.1121	4450	✓
Feedo 100 - 200	800	433.1122	5050	✓

**Controleer de juiste breedte!
Kontrollieren Sie die richtige Breite!
Check the correct width!**

B. Afdichtstrook / Dichtungstreifen / closure strip*

B1 Oorspronkelijk / ursprünglich / originally			
Amigo / Feedo	 A1 [mm]	Art.nr.	Verkrijgbaar Verfügbar Available
All	600/800	2 x 2,5 meter 281.0074 	✓

C. Geleideprofiel / Führungsprofil / guide profile*

C1 Oorspronkelijk / ursprünglich / originally			
Amigo / Feedo	 A1 [mm]	Art.nr.	Verkrijgbaar Verfügbar Available
All	600 / 800	2 x 902.0943 	✓

D. Afschermring / Dichtungsring / closure ring**

D1 Oorspronkelijk / ursprünglich / originally			
Amigo / Feedo	A1 ↔ [mm]	Art.nr.	Verkrijgbaar Verfügbar Available
All	600 / 800	3x 921.1200 + 1x 921.1201 	✓

E. Banddrijfrol / Antriebsrolle / Drive roller

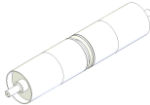
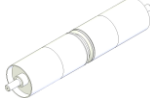
E1 Oorspronkelijk / ursprünglich / originally			
Amigo / Feedo	A1 ↔ [mm]	Art.nr.	Verkrijgbaar Verfügbar Available
All	600	969.4635 	✓
All	800	969.4636 	✓

F. Spanrol / Spannrolle / Tension roller

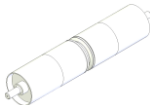
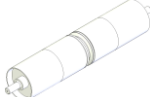

F1 Oorspronkelijk / ursprünglich / originally			
Amigo / Feedo	A1 ↔ [mm]	Art.nr.	Verkrijgbaar Verfügbar Available
All	600	969.4653 	✓
All	800	969.4654 	✓

G. Lager / Lager / bearing

G1 Oorspronkelijk / ursprünglich / originally			
Amigo / Feedo	A1 ↔ [mm]	Art.nr.	Verkrijgbaar Verfügbar Available
All	600 / 800	3x 900.0703 	✓

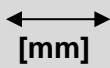

7. BOUWJAAR / BAUJAHR / CONSTRUCTION YEAR 2018 – 2022

A. Transportband / Querförderband / conveyor belt*

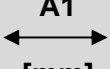

A1 Oorspronkelijk / ursprünglich / originally				
Amigo / Feedo	 [mm]	Art.nr.	 [mm]	Verkrijgbaar Verfügbar Available
Amigo 20	600	433.1123	4450	✓
Amigo 30S / 40S	600	433.1124	4650	✓
	800	433.1156	4650	✓
Amigo 30W	800	433.1156	4650	✓
Feedo 40L	800	433.1119	3250	✓
Feedo 40 / 50 / 60L	800	433.1120	3850	✓
Feedo 60 / 70 / 80	800	433.1121	4450	✓
Feedo 100 - 200	800	433.1122	5050	✓

**Controleer de juiste breedte!
Kontrollieren Sie die richtige Breite!
Check the correct width!**

B. Afdichtstrook / Dichtungstreifen / closure strip*

B1 Oorspronkelijk / ursprünglich / originally			
Amigo / Feedo	A1  [mm]	Art.nr.	Verkrijgbaar Verfügbar Available
All	600/800	2 x 2,5 meter 281.0074 	✓

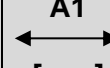
C. Geleideprofiel / Führungsprofil / guide profile*

C1 Oorspronkelijk / ursprünglich / originally			
Amigo / Feedo	A1  [mm]	Art.nr.	Verkrijgbaar Verfügbar Available
All	600 / 800	2 x 902.0943 	✓

D. Afschermring / Dichtungsring / closure ring**

D1 Oorspronkelijk / ursprünglich / originally			
Amigo / Feedo	A1 ↔ [mm]	Art.nr.	Verkrijgbaar Verfügbar Available
All	600 / 800	3x 921.1200 + 1x 921.1201 	✓

E. Banddrijfrol / Antriebsrolle / Drive roller

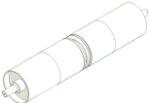
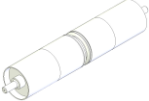
E1 Oorspronkelijk / ursprünglich / originally			
Amigo / Feedo	A1 ↔ [mm]	Art.nr.	Verkrijgbaar Verfügbar Available
All	600	969.4635 	✓
All	800	969.4636 	✓

F. Spanrol / Spannrolle / Tension roller

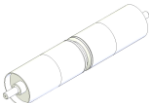
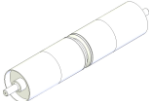
F1 Oorspronkelijk / ursprünglich / originally			
Amigo / Feedo	A1 ↔ [mm]	Art.nr.	Verkrijgbaar Verfügbar Available
All	600	969.4653 	✓
All	800	969.4654 	✓

G. Lager / Lager / bearing

G1 Oorspronkelijk / ursprünglich / originally			
Amigo / Feedo	A1 ←→ [mm]	Art.nr.	Verkrijgbaar Verfügbar Available
All	600 / 800	3x 900.0580 	✓

8. MONTAGE INSTRUCTIES / MONTAGE ANLEITUNG / ASSEMBLY INSTRUCTIONS

A. Transportband / Querförderband / conveyor belt

NL: Span de transportband tot een spanning van 0,5%. Dit betekent: wanneer de transportband ontspannen maar strak ligt, hij daarna nog zover gespannen dient te worden, dat deze 5 mm op 1 meter rekt. Dit is van toepassing op alle transportbanden.

DE: Spannen Sie das Querförderband auf eine Spannung von 0,5 %. Das bedeutet: Wenn das Querförderband ohne Spannung, aber dennoch straff anliegt, muss es noch so weit gespannt werden, dass es auf 1 m um 5 mm gedehnt ist. Dies gilt für alle Querförderbänder.

ENG: Tighten the conveyer belt to a tension of 0.5%, meaning that if the belt is slackened but lies flat, the tension must be increased by 5mm for every meter. This applies to all conveyor belts.

B. Banddrijfrol & Spanrol / Antriebsrolle & Spannrolle / Drive roller & Tension roller

NL: Controleer of de rollen evenwijdig lopen, door deze kruislings op te meten, op het hart van de as van de rollen. Wanneer lengte C gelijk is aan lengte D, zijn de rollen goed afgesteld. Dit is van toepassing op alle rollen.

DE: Prüfen Sie, ob die Rollen parallel laufen, indem diese über Kreuz messen. Messen Sie diagonal Mitte Förderbandrolle zur gegenüberliegenden Seite Mitte Förderbandrolle. Wenn Länge C gleich Länge D ist, sind die Rollen richtig eingestellt. Dies gilt für alle Rollen.

ENG: Check that the rollers are running parallel by measuring them in a crosswise manner at the centre of the axis of the rollers. In the following illustration, distance C must be equal to distance D. This applies to all rollers.

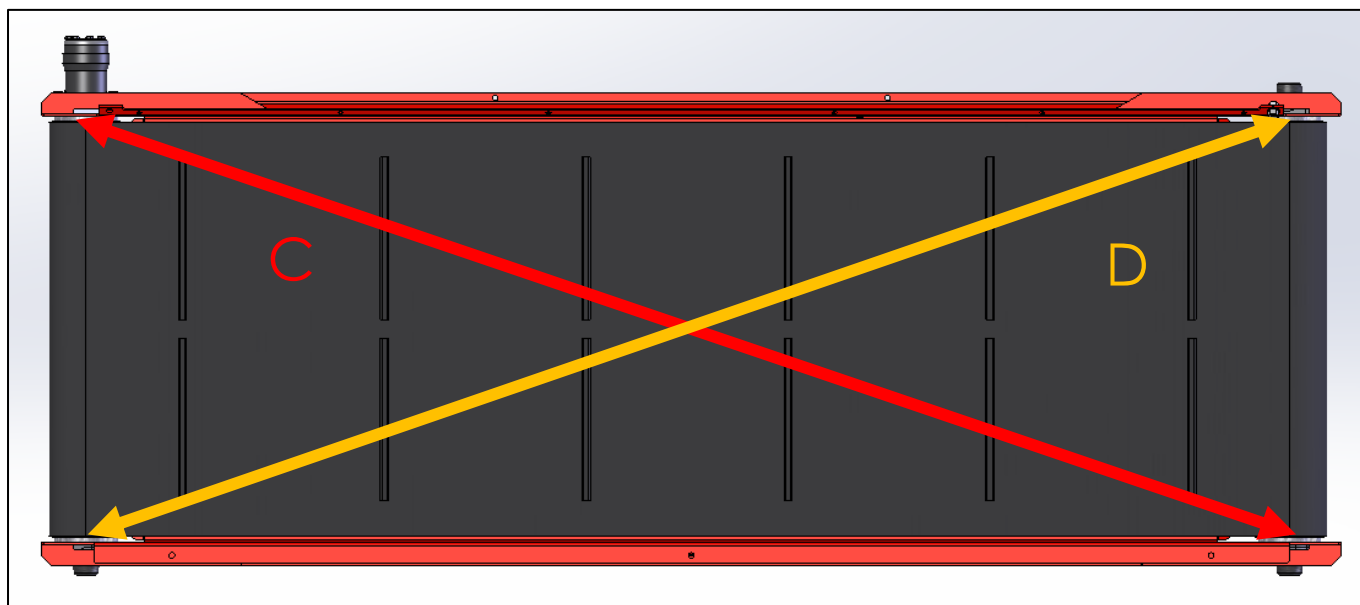

C. Olieopbrengst / Ölfluss / Oil flow

	Amigo	Amigo	Feedo	Feedo
Olidedruk / Öldruck / Oil pressure [Bar]	150	180	150	180
Min. Olieopbrengst / Min. Ölfluss / Min. Oil flow [L/min]	25	35	30	45

D. Geleideprofiel / Führungsprofil / guide profile

NL: Positioneer de nieuwe profielen 902.0943 voor het gatenpatroon in de dwarstransporteur, zodat alle gaten overeen komen. Controleer of het aluminiumprofiel zich op de juiste hoogte van de transportband bevindt. De hieronder opgegeven hoogtemaat dient gemeten te worden vanaf de bovenzijde van de plaat onder de dwarsband (E), tot het hart van het aluminium profiel (F).

DE: Die neuen Führungsprofile 902.0943 so positionieren, dass die Löcher am Wagen und die Löcher der Profile übereinstimmen. Prüfen Sie, ob sich das Aluminiumprofil in der richtigen Höhe des Förderbandes befindet. Das unten angegebene Maß muss von der Oberseite der Platte (E) unter dem Querförderband, bis zur Mitte der Kederführung (F) gemessen werden.

ENG: Position the new profiles 902.0943 in front of the hole pattern in the cross conveyor to make all holes match. Check that the aluminum profile is correctly aligned in relation to the conveyor belt. The below specified dimension should be measured from the top of the plate (E) beneath the conveyor belt, to the heart of the aluminum profile (F).

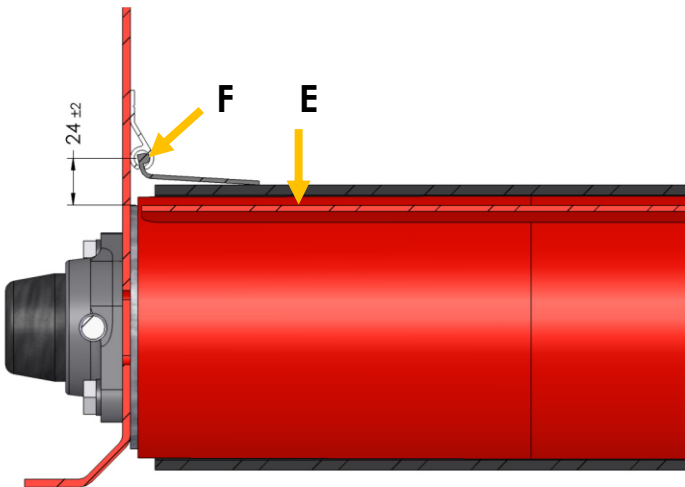

E. Afdichtstrook / Dichtungsstreifen / closure strip

NL: Schuif de afdichtstroken in de aluminium profielen, zoals hieronder afgebeeld. Knijp de profielen om de 50 cm stevig dicht, zodat de afdichtstroken niet meer kunnen schuiven.

Strijk de onderzijde van de afdichtstrook (contactoppervlak met transportband) goed in met vaseline. Dit voorkomt inbranding bij het eerste gebruik.

DE: Die Dichtungsstreifen wie rechts dar gestellt, in die Aluminiumprofile schieben. Die Profile alle 50 cm fest zusammen drücken, so dass die Dichtungsstreifen nicht mehr verrutschen können. **Die Unterseite des Dichtungsstreifens (Kontaktfläche mit dem Querförderband) reichlich mit Vaseline bestreichen.** Dies verhindert ein Einbrennen bei der ersten Verwendung.

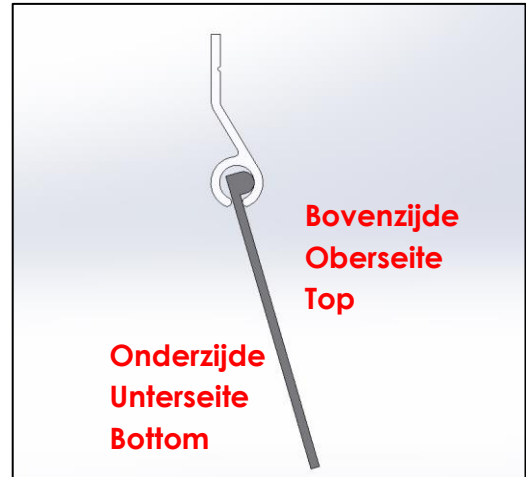

ENG: Slide the sealing strips into the aluminum profiles, as shown in the illustration below. Firmly squeeze the profiles every 50 cm to prevent the sealing strips from moving. **Apply a good measure of Vaseline to the bottom of the sealing strip (contact surface with the conveyor belt).** This will prevent the risk of burning when first put into use.

9. FOTO'S ARTIKELEN / BILDER ARTIKELN / PHOTOS ARTICLES



401.0171



376.0175

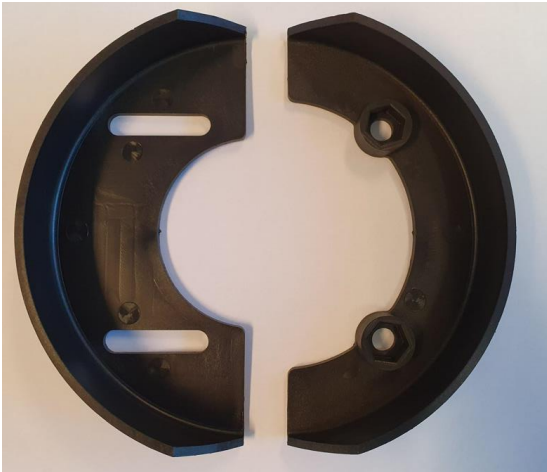

360.0005